

3/4" NPT PP
Flow Spigot #16484

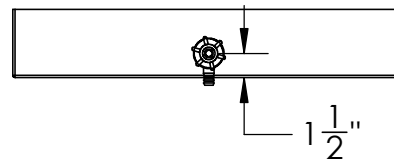

Polypropylene Tray/Tip
Plating Tank #15475

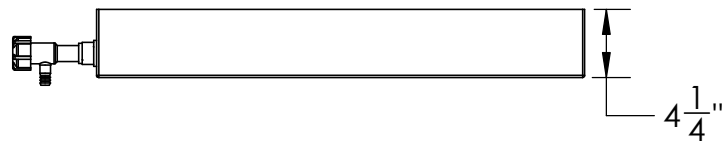
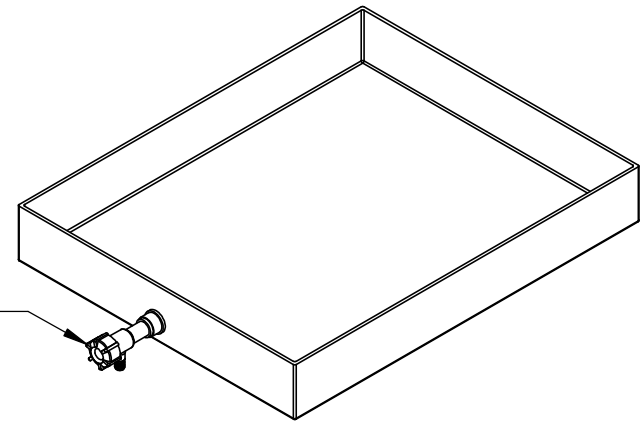

1390 Neubrecht Road
Lima, Ohio 45801

STOCK NO.

15475

REV

A

DO NOT SCALE DRAWING

WEIGHT: 11 lbs.

DIMENSIONS ARE IN INCHES TOLERANCE: $\pm 1/4$ "		NAME	DATE
MATERIAL	WELDED PP	DRAWN	JMP 6/6/19
CAPACITY	N/A	APPROVED	
GRADUATIONS	N/A	COMMENTS: Other tray sizes, special partitions, flanges, outlets, etc. are available	
NOMINAL WALL THICKNESS	1/4"		

PROPRIETARY AND CONFIDENTIAL

THE INFORMATION CONTAINED IN THIS DRAWING IS THE SOLE PROPERTY OF TAMCO. ANY REPRODUCTION IN PART OR AS A WHOLE WITHOUT THE WRITTEN PERMISSION OF TAMCO IS PROHIBITED.

MAX. OPERATING TEMP. 140°F
INTERMITTENT SERVICE TO 160°F
SEE CHEMICAL RESISTANCE
CHART FOR COMPATIBILITY