

*NOTE:
 ADDITIONAL CLEARANCE REQ'D
 FOR SCREEN REMOVAL: 4"

Parts List			
Item	Qty	PART NO.	DESCRIPTION
1	1	LS075B	LINE STRAINER BODY
2	1	LS075XC1	LINE STRAINER CAP
3	1	LS075G	LINE STRAINER GASKET
4	1	12723	DRAIN PLUG
5	1	12724	DRAIN PLUG GASKET
6	1	LS780	LINE STRAINER SCREEN

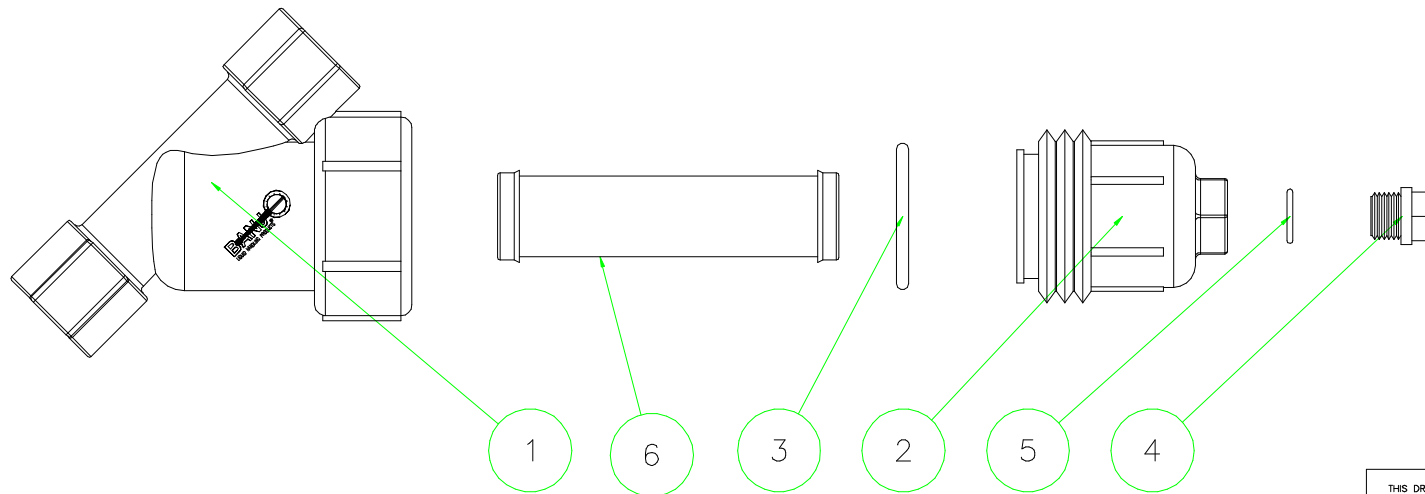
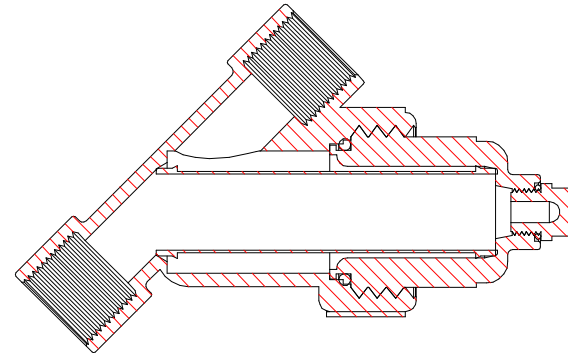
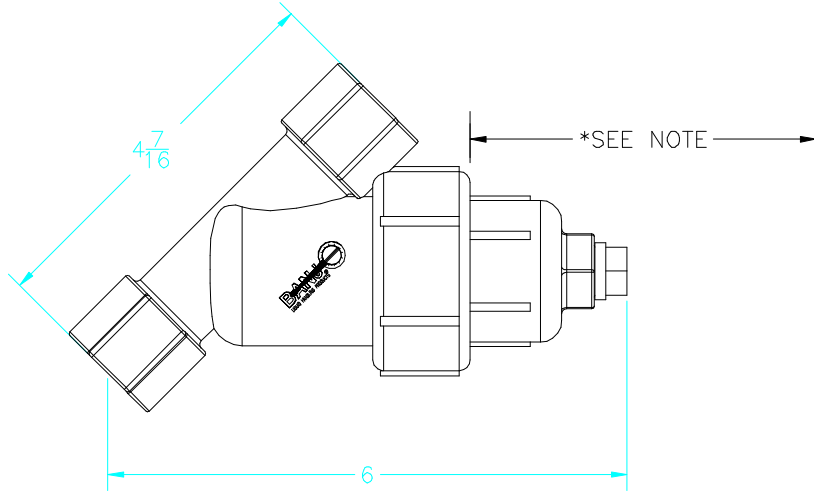
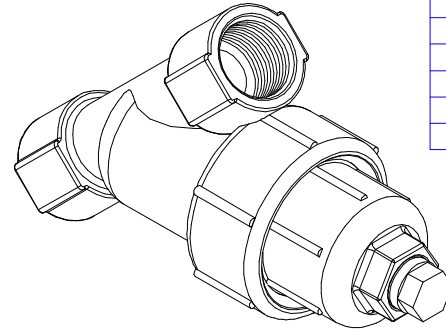

BANJO
 LIQUID HANDLING PRODUCTS

BANJO CORPORATION
 150 BANJO DR. * CRAWFORDSVILLE, IN 47933

PART NO. LS075-80

TITLE 3/4" LINE STRAINER W/ #80 MESH SCREEN

THIS DRAWING AND ALL INFORMATION
 CONTAINED THEREON ARE THE EXCLUSIVE
 PROPERTY OF BANJO CORPORATION.
 UNLESS SPECIFICALLY NOTED, THIS
 DRAWING AND ITEMS SHOWN ON THIS
 DRAWING ARE SUBJECT TO CHANGE
 AT ANY TIME.