

ProCon® — R7 Series with NEXUS® ORP Sensor Transmitter

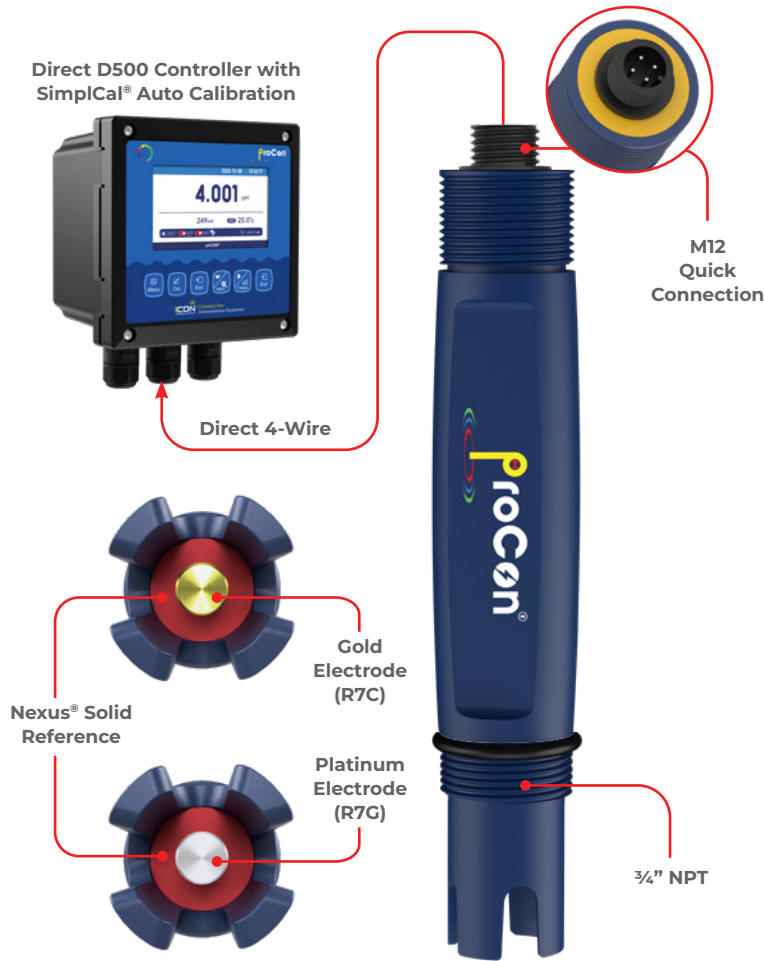

Corrosion-Free
Instrumentation Equipment



- ✓ 4-20mA Output
- ✓ Temperature Compensated
- ✓ Nexus® Solid KCl Reference
- ✓ Gold/Platinum Electrode
- ✓ No Preamp Required
- ✓ Quick Response Time
- ✓ RS 485 Modbus Communication

The gold standard of high performance industrial ORP sensor transmitters for complex applications

The ProCon® R7 Series with Nexus® has been engineered for ruggedness, longevity and accuracy, and features a choice between gold and platinum electrodes for enhanced accuracy.

The double junction coupled with the solid Nexus® KCl infused reference makes the R7 Series ORP sensor transmitter an excellent choice for wide range of process media applications.

All measurement functions are combined in one compact body — measuring electrode, temperature sensor and an inner reference chamber.

The 2-wire 4-20mA, 4-wire or 4-20mA + RS485 output options simplify calibration and communication with remote displays and controllers.

- ✓ Solid Nexus® reference extends sensor life and protects against poisoning ions
- ✓ Operates in sub-zero temperatures down to 14°F (-10°C)
- ✓ Advanced electronics provide excellent repeatability and reliability using cutting edge algorithmic diagnostics

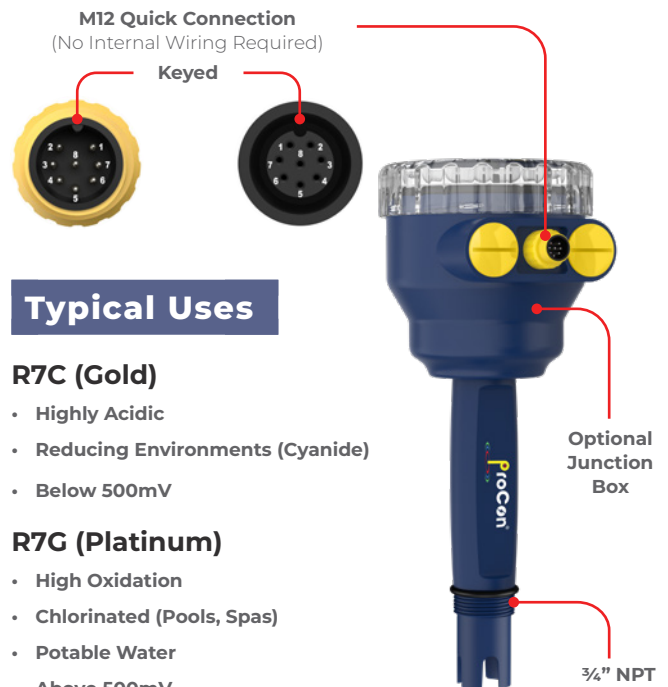
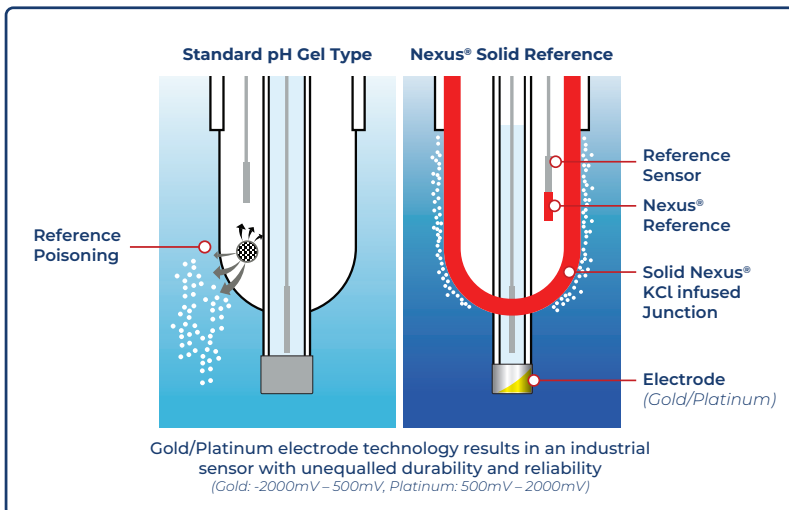

Typical Uses

R7C (Gold)

- Highly Acidic
- Reducing Environments (Cyanide)
- Below 500mV

R7G (Platinum)

- High Oxidation
- Chlorinated (Pools, Spas)
- Potable Water
- Above 500mV

Smart Sensor Technology

Advanced electronic circuitry stores ORP data for automatic sensor recognition and trouble-free calibration when connected to the ProCon® Controller.

Outputs

1. 4-20mA 2-Wire
2. 4-20mA + RS485

Both the measuring and reference electrodes are encapsulated within the non-porous advanced KCl infused polymer known as Nexus®.

Less Calibration and Maintenance

Most sensors require on-going recalibration and are prone to premature failure due to what is known as gradient drift, or sensor drift.

The Nexus® series is a solid reference material. Poisoning or leaching of the reference electrolyte that occurs in standard sensors is greatly reduced.

The Nexus reference helps to eliminate the need for ongoing maintenance or cleaning requirement due to fouling or film build up removal which occurs with many process applications with traditional ORP sensors.

Faster Response-Longer Lasting

The solid Nexus® reference provides for faster response time to changing ORP values since there is no requirement for a junction.

- ✓ No Costly Preamps Required
- ✓ Direct 4-20mA & RS485 Outputs

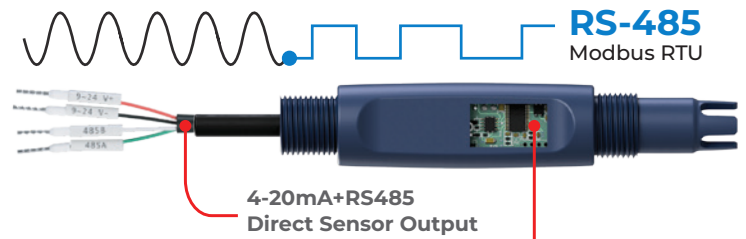

Advanced electronic circuitry stores ORP data for automatic sensor recognition and trouble-free calibration when connected to the ProCon® Controller

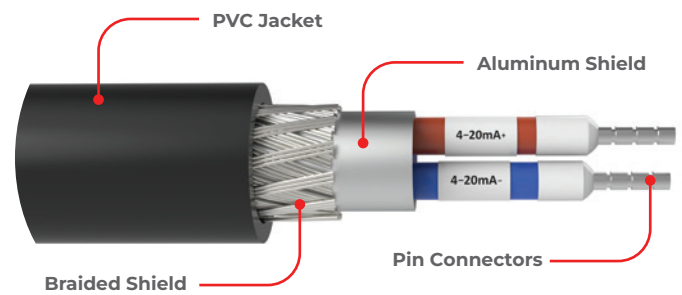

Enhanced chip technology allows for remote calibration as well as diagnostic data

Data analysis and direct 4-20mA signal or RS485 Digital outputs

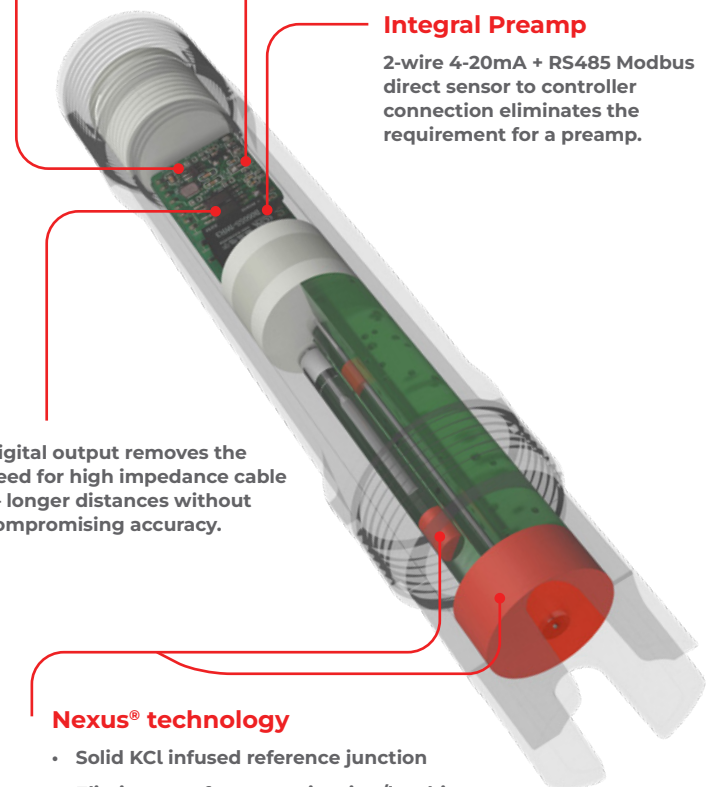

Nexus® technology

- Solid KCl infused reference junction
- Eliminates reference poisoning/leaching
- Extended life expectancy

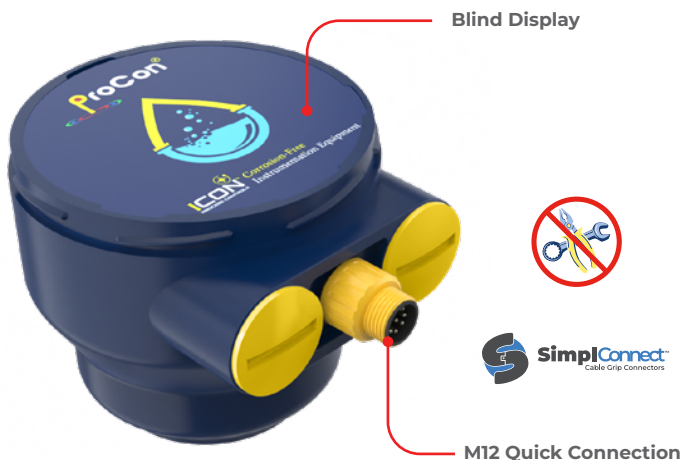



Specifications

Measurement Range	
ORP	-1000mV – 1000mV
Output Signal — No Preamp Required	
2 Wire Loop Powered 4-20mA + RS 485 Direct Sensor Output	
Accuracy	
± 1mV	
Operating Temperature	
14 to 176°F -10 to 80°C Automatic Temperature Compensation	
Maximum Pressure	
145 Psi 10 bar	
Design	
Sensor body	PP Polypropylene (std) Ryton® PPS
Reference System	3.3 Mol Ag / AgCl / KCl Double Junction
pH electrode	Gold (R7C) Platinum (R7G)
Reference	Solid Nexus®
Connection	3/4" NPT
Measuring Electrode Resistance	< 500 MΩ
Impedance Range	102 – 675 MΩ
Temperature Compensation/Output- 4-20 + RS485 Model	
Pt-1000 (Std)	
Pt-100	

Temperature Control

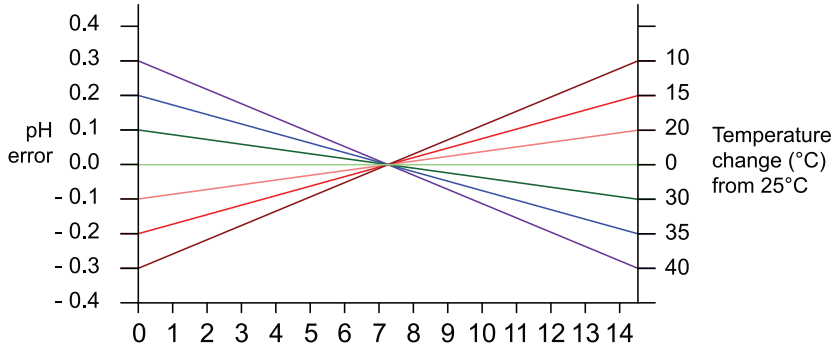

Temperature vs. Pressure

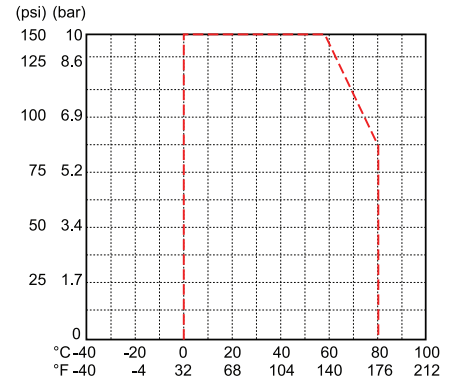

In-line Mounting

1. Avoid vertical installation. (air may be present)
2. Optimum installation 15° above horizontal.
3. Process liquid should flow upward. (for downward flow ensure backpressure is present in order to avoid air within pipe)

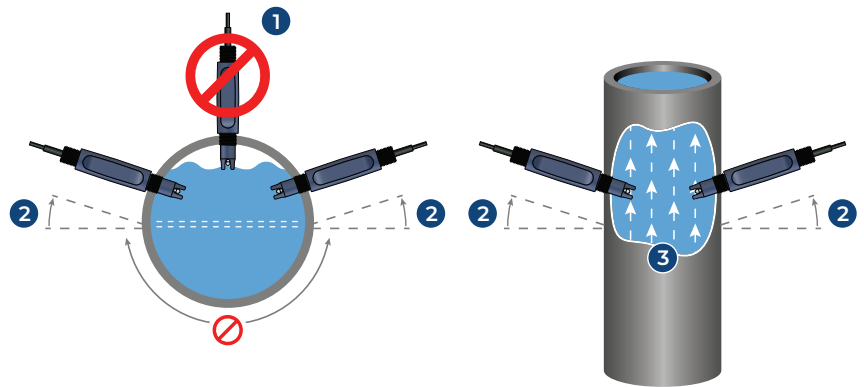

Typical Application

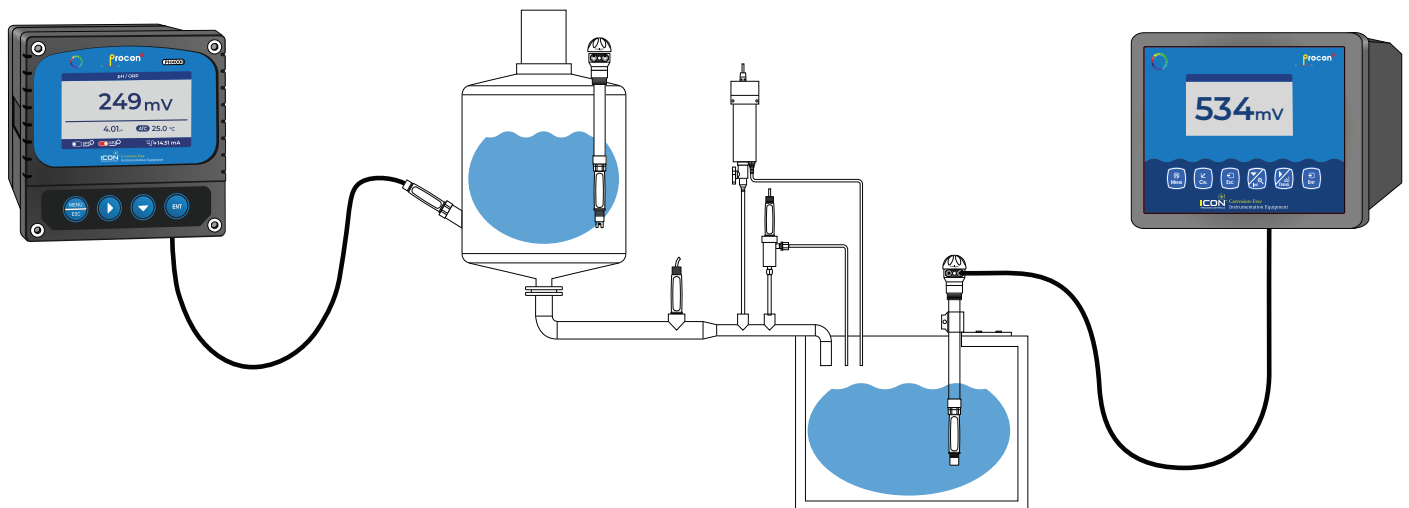

Wiring

4-20mA 2-wire

- 1 Blue: mA-
- 2 Brown: mA+

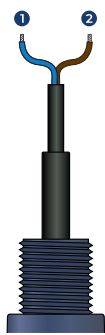

4-20mA 4-wire

- 1 Transparent: 4-20mA
- 2 Black (thick): Ref
- 3 White: Temperature
- 4 Green: Temperature

Connects directly to ProCon® controller

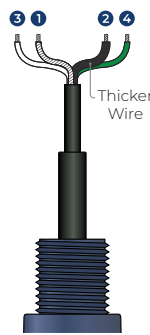

4-20mA + RS485 Output

- 1 Red: 9-24VDC +
- 2 Black: 9-24VDC -
- 3 Transparent: 4-20mA
- 4 Black (thick): Ref
- 5 Green: RS 485 A
- 6 White : RS 485 B

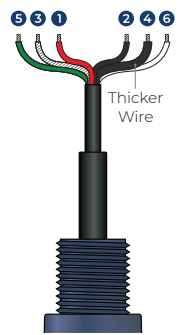

Wiring — M12

4 Pin M12 Connection

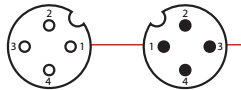

M12 - Male M12 - Female



■ 4-20mA | 4 Pin

Color	Description
Pin 1 – Brown	4-20mA +
Pin 2 – Blue	4-20mA -

■ 4-20mA + Controller | 4 Pin

Color	Description
Red	Temperature
Black	Temperature
Black (Thick)	Reference
Transparent	4-20mA

8 Pin M12 Connection



M12 - Female



■ 4-20mA + RS485 | 8 Pin

Color	Description
Red	9-24 VDC +
Black	9-24 VDC -
Transparent	4-20mA
Black (Thick)	Reference
Green	RS485 A
White	RS485 B

4 Pin IO - Link Connection



■ I-O Link | 4 Pin

Pin	Description
Pin 1	24 VDC +
Pin 2	
Pin 3	GND
Pin 4	4-20mA

Dimension

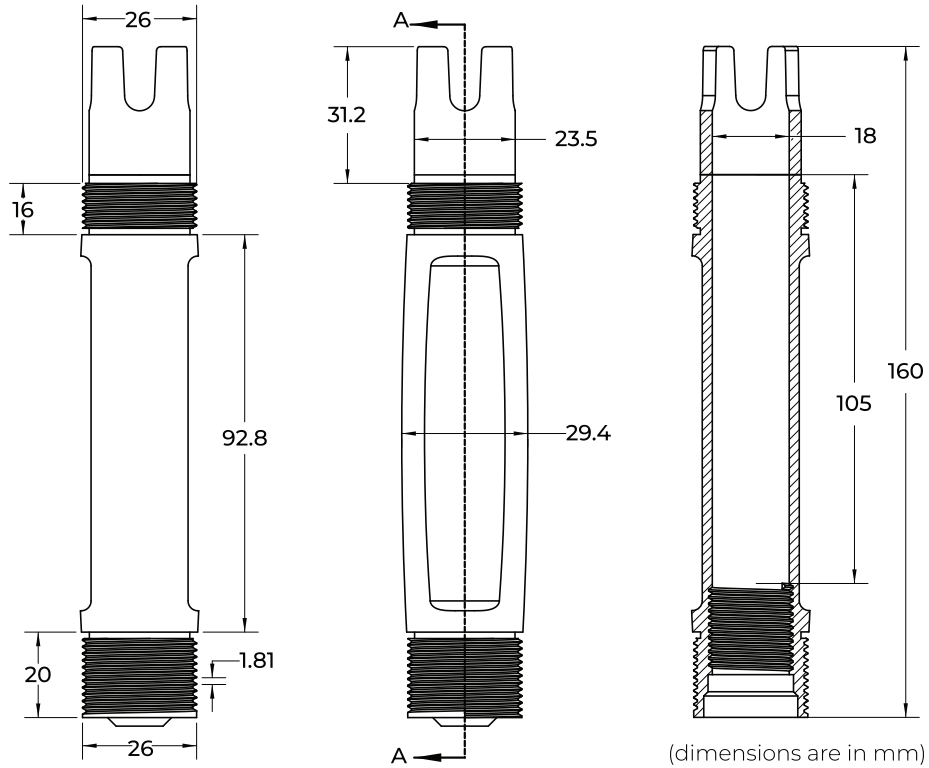

Model Selection

R7 **C** - **P** - **M** - **1** - **F** - **M**

Electrode	Material	Output	Electrode	Connection
C: Complex (Gold: ORP<500mV) G: General (Platinum: ORP>500mV)	P: PP (std) R: Ryton®	M: 4-20mA (2-wire) D: 4-wire (for ProCon® display) S: RS485 + 4-20mA	1: PT1000 (std)	M: M12 B: Blind (J-Box) D: Display (J-Box) F: Flying Lead

Fittings

Easy Install Clamp On Pipe Saddles

Part Number	Material	Size	Seal	Thread	Connection
PSA-2	PVC	2"	FPM	3/4" NPT	PVC
PSA-3	PVC	3"	FPM	3/4" NPT	PVC
PSA-4	PVC	4"	FPM	3/4" NPT	PVC
PSA-6	PVC	6"	FPM	3/4" NPT	PVC
PSA-8	PVC	8"	FPM	3/4" NPT	PVC



True Union Tee Fitting

Part Number	Material	Size	Seal	Thread	Connection
TUPA-PV-5	PVC	1/2"	FPM (std) EPDM	3/4" NPT	Socket NPT
TUPA-PP-5	PP	1/2"	FPM (std) EPDM	3/4" NPT	Butt NPT
TUPA-PF-5	PVDF	1/2"	FPM (std) EPDM	3/4" NPT	Butt NPT
TUPA-PV-7	PVC	3/4"	FPM (std) EPDM	3/4" NPT	Socket NPT
TUPA-PP-7	PP	3/4"	FPM (std) EPDM	3/4" NPT	Butt NPT
TUPA-PF-7	PVDF	3/4"	FPM (std) EPDM	3/4" NPT	Butt NPT
TUPA-PV-1	PVC	1"	FPM (std) EPDM	3/4" NPT	Socket NPT
TUPA-PP-1	PP	1"	FPM (std) EPDM	3/4" NPT	Butt NPT
TUPA-PF-1	PVDF	1"	FPM (std) EPDM	3/4" NPT	Butt NPT
TUPA-PV-15	PVC	1 1/2"	FPM (std) EPDM	3/4" NPT	Socket NPT
TUPA-PP-15	PP	1 1/2"	FPM (std) EPDM	3/4" NPT	Butt NPT
TUPA-PF-15	PVDF	1 1/2"	FPM (std) EPDM	3/4" NPT	Butt NPT
TUPA-PV-2	PVC	2"	FPM (std) EPDM	3/4" NPT	Socket NPT
TUPA-PP-2	PP	2"	FPM (std) EPDM	3/4" NPT	Butt NPT
TUPA-PF-2	PVDF	2"	FPM (std) EPDM	3/4" NPT	Butt NPT

