

EAU129 SERIES

ACTUATOR OPERATIONAL CONCEPTS

The EAU129 Series Actuator is a unidirectional, quarter-turning 90° CCW industrial electric actuator designed to operate thermoplastic valves in municipal, commercial and industrial applications. These units are NEMA 4/4X, and feature on/off control.

TABLE OF CONTENTS

Actuator Operational Concepts	1	Wire Sizing Chart	4
Table of Contents	1	Wiring Diagram And Setup	4
Important Safety Instructions	2	Commissioning	4
Actuator Handling And Installation	3	Mechanical Data	5
Product Mounting And Setup	3	Technical Information	5

Notice: EAU129 Series Actuators are unidirectional and rotate CCW in 90° quadrants without a reversing function. The rotation direction is viewed from ABOVE the actuator.

Notice: There are no travel adjustments and there are no mechanical stops in the EAU129 Series.

TO PREVENT POTENTIAL INJURY OR DAMAGE TO PROPERTY, READ THIS MANUAL CAREFULLY AND COMPLETELY.

USE ONLY HAYWARD GENUINE REPLACEMENT PARTS

IMPORTANT SAFETY INSTRUCTIONS

Basic safety precautions should always be followed, including the following: Failure to follow instructions can cause severe injury and/or death.

 This is the safety-alert symbol. When you see this symbol on your equipment or in this manual, look for one of the following signal words and be alert to the potential for personal injury.

 **WARNING** warns about hazards that could cause serious personal injury, death or major property damage and if ignored presents a potential hazard.

 **CAUTION** warns about hazards that will or can cause minor or moderate personal injury and/or property damage and if ignored presents a potential hazard. It can also make consumers aware of actions that are unpredictable and unsafe.

Notice: A notice indicates special instructions that are important but not related to hazards.



 **WARNING** - Read and follow all instructions in this IOM manual and on the equipment. Failure to follow instructions can cause severe injury and/or death.





 **WARNING** – Risk of Electric Shock. All electrical wiring **MUST** be in conformance with applicable local codes, regulations, and the National Electric Code (NEC). Hazardous voltage can shock, burn, and cause death or serious property damage. To reduce the risk of electric shock, do **NOT** use an extension cord to connect unit to electric supply. Provide a properly located electrical receptacle. Before working on any electrical equipment, turn off power supply to the equipment.

 **WARNING** – To reduce the risk of electric shock replace damaged wiring immediately.

 **WARNING** – Ground all electrical equipment before connecting to electrical power supply. Failure to ground all electrical equipment can cause serious or fatal electrical shock hazard.

 **WARNING** – Do **NOT** ground to a gas supply line.

 **WARNING** – To avoid dangerous or fatal electrical shock, turn **OFF** power to all electrical equipment before working on electrical connections.

 **WARNING** – Failure to bond all electrical equipment to system structure will increase risk for electrocution and could result in injury or death. To reduce the risk of electric shock, see installation instructions and consult a professional electrician on how to bond all electrical equipment. Also, contact a licensed electrician for information on local electrical codes for bonding requirements.

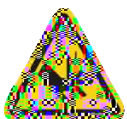

 **CAUTION** – Potential pinch point. Equipment connected to or driven by this device may start unexpectedly and may cause personal injury or entrapment in linkage systems.

ACTUATOR HANDLING AND INSTALLATION

SHIPPING AND HANDLING

1. Position on arrival:
 - An unmounted actuator is delivered in the OPEN position which also means the auxiliary switch is closed between terminals 6 and 7. (For proper position and indication, mount this actuator to your valve with the valve and actuator in the open position).
 - A 2 way ball valve assembly arrives in the FULLY OPEN (CCW) position.
2. Storage: This unit should not be stored outside unless it is powered up and has proper conduit terminations. When not powered up, it should be stored in a clean, dry environment at all times.
3. This quarter-turn actuator has been factory tested for operation between 0° and 90°. There are no travel adjustments.
4. **Notice:** The EAU129 Series actuators have no mechanical stops to limit rotation.
5. **Notice:** Protect the actuator from moisture by installing it with water tight EMT fittings and proper conduit drainage. There is no internal heater.

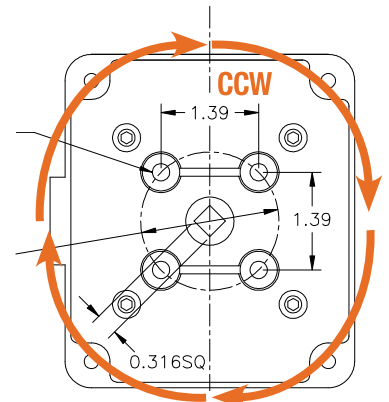

Rotation seen from below is a mirror of the direction viewed from above.



WARNING – To avoid dangerous or fatal electrical shock, turn OFF power to all electrical equipment before working on electrical connections.

INSTALLATION NOTES



CAUTION – Please follow the following guidelines for proper installation.

- These actuators are designed to be used between a horizontal and upright position. Do NOT mount the assembly with the actuator top below a horizontal position (i.e. upside down).
- When installing conduit, use proper techniques for entry into the actuator. Use drip loops to prevent conduit condensate from entering the actuator.
- The EMT conduit port MUST use proper fittings to protect the NEMA 4X integrity of the housing.
- Use proper wire size to prevent actuator failure (see Wire Sizing Chart for proper wire sizing).
- All terminals accept 12-18AWG solid/stranded wire.

PRODUCT MOUNTING AND SETUP

Notice: All EAU129 Series actuators rotate CCW to close the output shaft out the bottom of the actuator **when viewed from above**. The actuator is unidirectional and rotates 90° with each control signal input.

1. Fully OPEN the valve to which the actuator is to be mounted.
2. Assemble necessary linkage hardware and attach the actuator to the valve.
3. Center the actuator on the valve drive shaft and tighten all hardware.
4. Make the electrical connections per the Wiring Diagram.

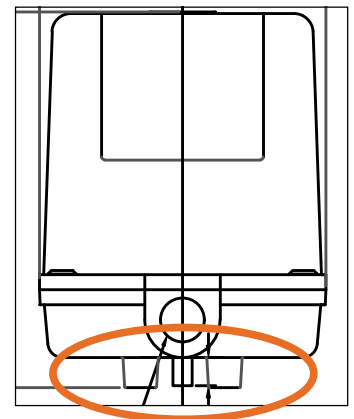

Position Indication - The coupling is visible between the actuator and the mounted valve, allowing the user to see the position of the valve.

WIRE SIZING CHART

Wire sizing data is provided in the table to assist in the selection of the proper wire size for EAU129 Series actuators using various wire sizes over distance.

Be sure to reference the correct voltage and do not exceed the indicated length of the wire run for each model.

Maximum distance between Actuator and Power Supply (ft)

ACTUATOR	EAU129 12A~12D	EAU129 24A~24D	EAU129	EAU129 220A
	12VAC/VDC	24VAC/VDC	120VAC	230VAC
Voltage	4.80	2.40	1.80	0.90
AWG \ Amps				
18	17	69	459	1760
16	27	108	722	2766
14	44	175	1166	4468
12	67	267	1783	6833
10	114	455	3030	11616
8	170	678	4523	17338

WARNING – To avoid dangerous or fatal electrical shock, turn OFF power to all electrical equipment before working on electrical connections.

WIRING DIAGRAM AND SETUP

Wiring diagram is common for all voltages in this document.

1. Screw terminals are rated to accept 14AWG down to 18AWG solid or stranded wire. **TERMINAL NUMBERING HAS #1 AT LEFT and #8 AT RIGHT.**
2. Make the electrical connections per the Wiring Diagram.
3. Connect POWER and CONTROL to the correct terminals.
4. Terminals 6~8 on each actuator are for the aux switch. It has dry type (volt free) Form A contacts rated 250VAC @ 10A Max.

Wiring diagram is shown in the full open position.

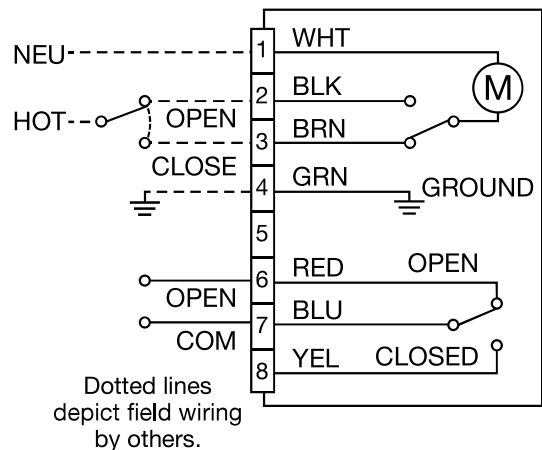

COMMISSIONING

Commissioning Procedure - On/Off Control

1. Apply correct power to the unit.
2. Measure correct power and polarity as shown in the wiring diagrams.
3. Command the field device to generate an OPEN signal.
 - The actuator rotates 90° in the CCW direction (as viewed from above).
4. Measure connections between terminals 1 and 2.
 - The actuator will stop after it rotates 90° CCW (as viewed from above).
 - Measure the continuity between wires #6 & #7 to show the Aux switch is closed (valve OPEN position indication).
5. Command the field device to generate a CLOSED signal.
 - The actuator rotates 90° in the CCW direction (as viewed from above).
6. Measure connections between terminals 1 and 3.
 - The actuator will stop after it rotates 90° CCW (as viewed from above).
 - Measure the continuity between wires #7 & #8 to show the Aux switch is closed (valve CLOSED position indication).
7. Actuator is now commissioned and operational.

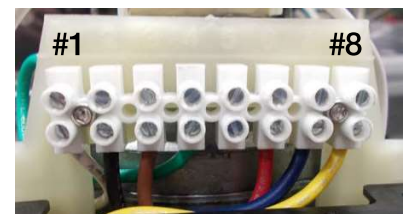

Terminal strips facilitate ease of field wiring and testing.



MECHANICAL DATA

ALLOW 6"
ABOVE FOR
COVER REMOVAL
CLEARANCE

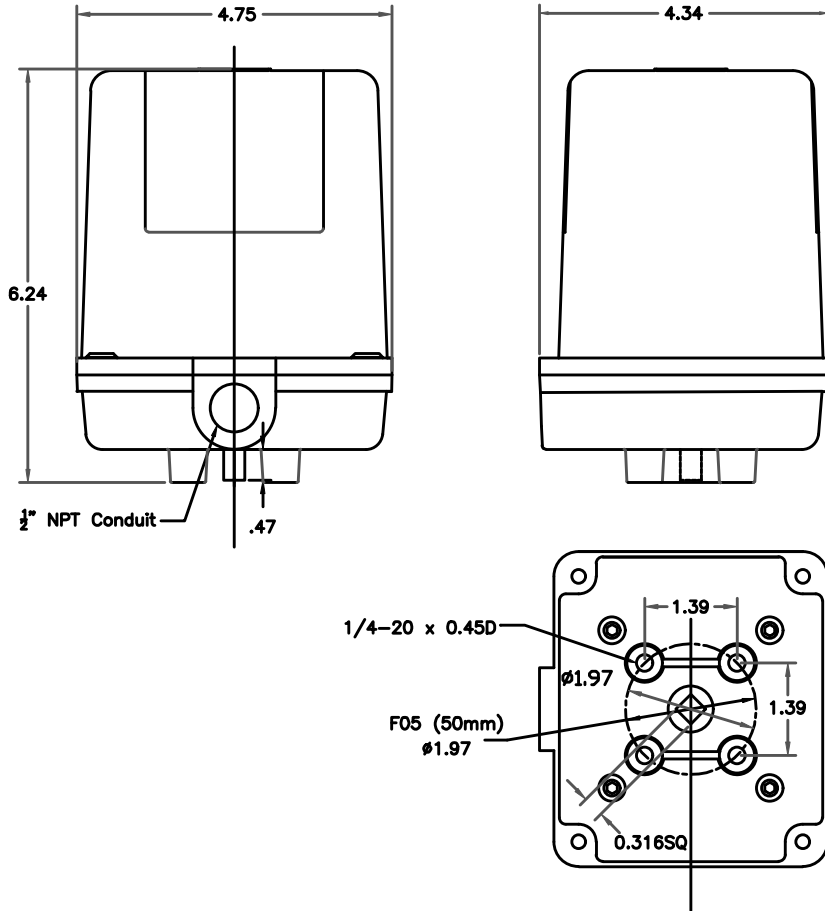

TECHNICAL INFORMATION

ACTUATOR SPECIFICATIONS

MODEL	EAU129	EAU12912A	EAU12912D
Torque Output (l bs / Nm)	120 / 13.5	120 / 13.5	120 / 13.5
Current Draw	1.8A	4.8A	4.8A
Voltage	120VAC	12VAC	12VDC
Drive Cycle	90°	90°	90°
Speed (90°) seconds, 60 Hz	2.5	2.5	2.5
Motor, Type	120VAC	12VAC	12VDC
Duty Cycle (on/off)	25%	25%	25%
Motor Starts, per hour, Max	1200	1200	1200
Motor Protection, Temp / Class	130°C / Class B	130°C / Class B	130°C / Class B
MODEL	EAU12924A	EAU12924D	EAU129220A
Torque Output (l bs / Nm)	120 / 13.5	120 / 13.5	120 / 13.5
Current Draw	2.4A	2.4A	0.9A
Voltage	24VAC	24VDC	220VAC
Drive Cycle	90°	90°	90°
Speed (90°) seconds, 60 Hz	7.5	2.5	2.5
Motor, Type	24VAC	24VDC	220VAC
Duty Cycle (on/off)	25%	25%	25%
Motor Starts, per hour, Max	1200	1200	1200
Motor Protection, Temp / Class	130°C / Class B	130°C / Class B	130°C / Class B

COMMON TO ALL

Electrical Entry (1)	1/2" EMT x 1 Port
Control	On/Off Control Only
Humidity Range	0-95% RH
Housing	GFPP enclosure, NEMA 4/4X
Mount	ISO 5211 F05 x 0.316 Male Drive, Offset 45°
Operation	Unidirectional - CCW (viewed from above the actuator)
Auxiliary Switch	10A 230VAC (Resistive) SPDT x 1, End of Travel Dry Contact
Thermal Protection	UL Listed Motor Thermal Protection
Position Holding	Mechanical Brake Motor

This page intentionally left blank

